

# START HERE!

## READ ME FIRST

Don't be a hero and muscle through this installation without reading these fitting instructions first! Improper installation of this gear may void certain aspects of your warranty.

Before you begin, take a moment and open all your Front Runner rack kit boxes and gather the assembly instructions for the various components.

A complete kit will contain:

1. A Front Runner Mounting System specific to your vehicle
2. A Front Runner Rack Tray or Load Bar Slats

This document will guide you through the assembly of the mounting system and assist you in fitting the roof rack tray or load bars to your specific vehicle.

Please refer to the next page for a list of all the components, quantities and tools required.

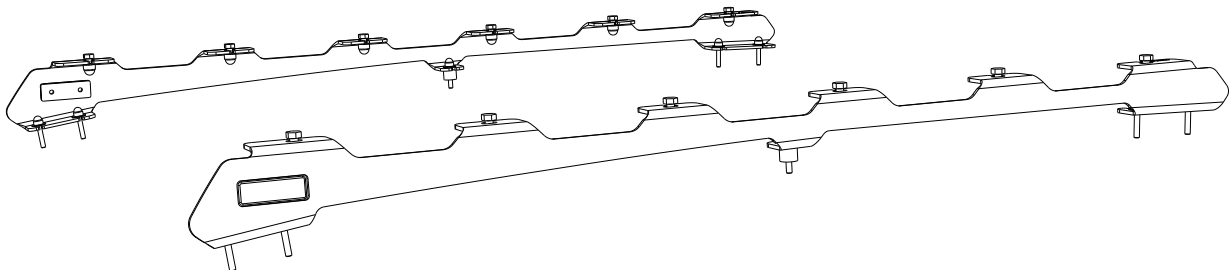

### IMPORTANT WARNING!

IT IS CRITICAL THAT ALL FRONT RUNNER PRODUCTS BE PROPERLY AND SECURELY ASSEMBLED AND ATTACHED TO YOUR VEHICLE. IMPROPER ATTACHMENT COULD RESULT IN AN AUTOMOBILE ACCIDENT, AND COULD CAUSE SERIOUS BODILY INJURY OR DEATH. YOU ARE RESPONSIBLE FOR ASSEMBLING AND SECURING ALL FRONT RUNNER PRODUCTS TO YOUR VEHICLE, CHECKING THE ATTACHMENTS PRIOR TO USE, AND PERIODICALLY INSPECTING THE PRODUCTS FOR ADJUSTMENT, WEAR AND DAMAGE. THEREFORE, YOU MUST READ AND UNDERSTAND ALL OF THE INSTRUCTIONS AND PRECAUTIONS SUPPLIED WITH YOUR FRONT RUNNER PRODUCT PRIOR TO INSTALLATION OR USE. IF YOU DO NOT UNDERSTAND ALL OF THE INSTRUCTIONS AND CAUTIONS, OR IF YOU HAVE NO MECHANICAL EXPERIENCE AND ARE NOT THOROUGHLY FAMILIAR WITH THE INSTALLATION PROCEDURES, YOU SHOULD HAVE THE PRODUCT INSTALLED BY A PROFESSIONAL INSTALLER OR OTHER QUALIFIED PERSONNEL.

**NOTE:** Front Runner will not be responsible for any damage caused by the failure to install the product according to these instructions.

Please call us if you have any questions about the installation of this product.

# 1

## GET ORGANIZED

### IN THE BOX

1	2 X	Foot Rail 1LH + 1RH
2	2 X	Spacer 19 x 12.5 x 15
3	8 X	Spacer 19 x 12.5 x 20
4	10 X	M6 Nut Cup
5	10 X	M6 x 35 Hex Bolt
6	10 X	M6 Spring Washer
7	10 X	M6 x 19 x 1SS Flat Washer
8	12 X	M8 x 20 Hex Bolt
9	12 X	M8 x 16 x 1.6SS Flat Washer
10	12 X	M8 Nyloc Nut
11	12 X	M8 Nut Cap

### TOOLS NEEDED

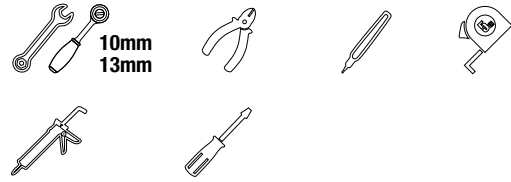
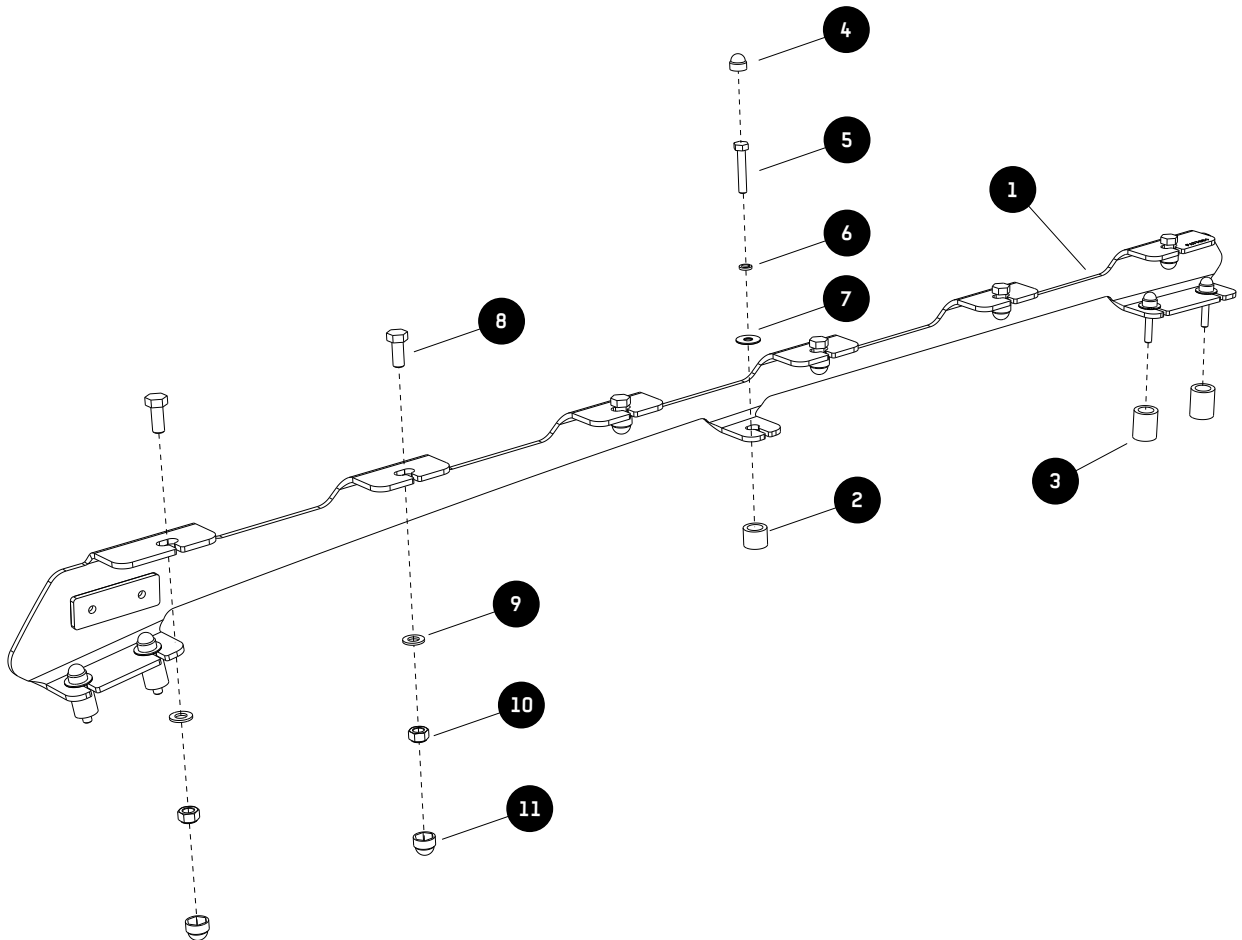

FIGURE 1.1



2.1



Using a flat screw driver and starting from the front of the vehicle, lift and remove the two ditch moldings running along either side of the roof.

Remove the tape covering the ten mounting points in the gutter (five on each side). Insert and hand tighten the ten M6 x 35 Hex Bolts (Item 5) supplied to the mounting points.

Starting at the front of the vehicle, refit the ditch molding. Whenever you reach one of the hex bolts that you have inserted, take a white marking pen and mark the top of the hex bolt. While the white "paint" is still wet, press the ditch molding onto the head of the bolt, transferring the position of the bolt head onto the underside of the ditch molding.

Repeat this process for all the bolts on both ditch moldings. When done, remove all the Hex Bolts.

2.2

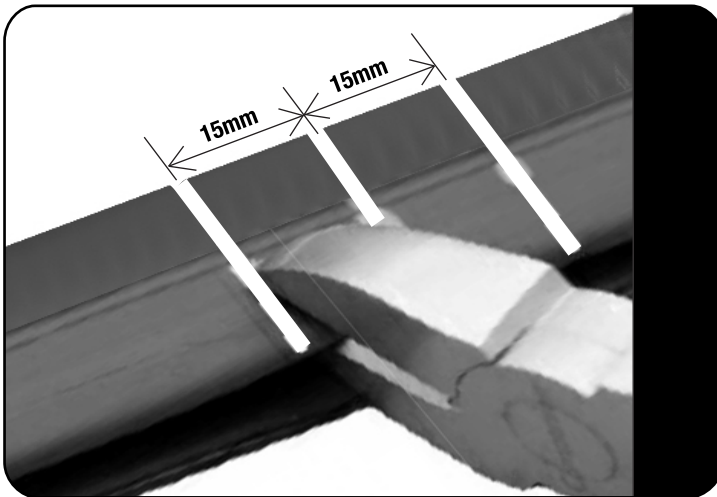

Working on the underside of the ditch molding, measure and mark a line 15mm either side of your original markings from Step 2.1 as shown in Step 2.2.

Using a pair of side cutters and a utility knife, remove the marked section of the ditch molding as shown in Step 2.2 through to Step 2.4.

2.3



Refer to Step 2.2.

2.4

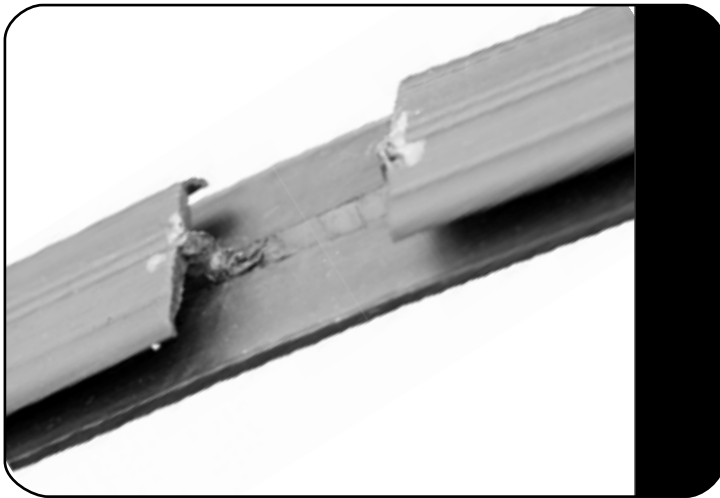

Refer to Step 2.2.

2.5

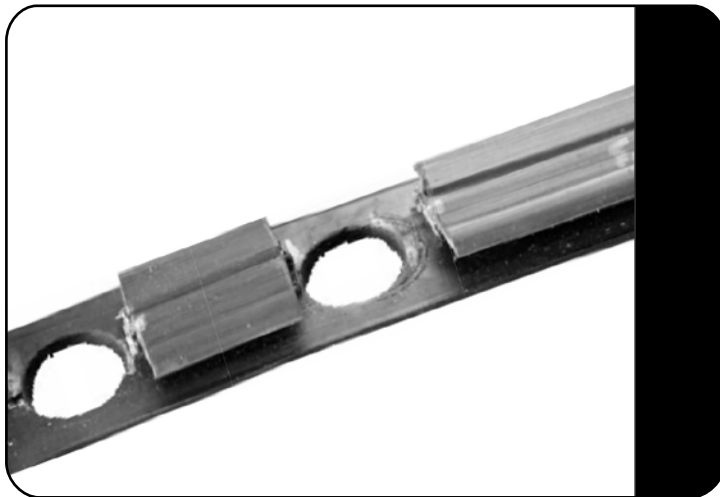

Using a 22mm hole punch "recommended" or hole saw, punch/drill holes through the ditch molding on each of your markings.

2.6

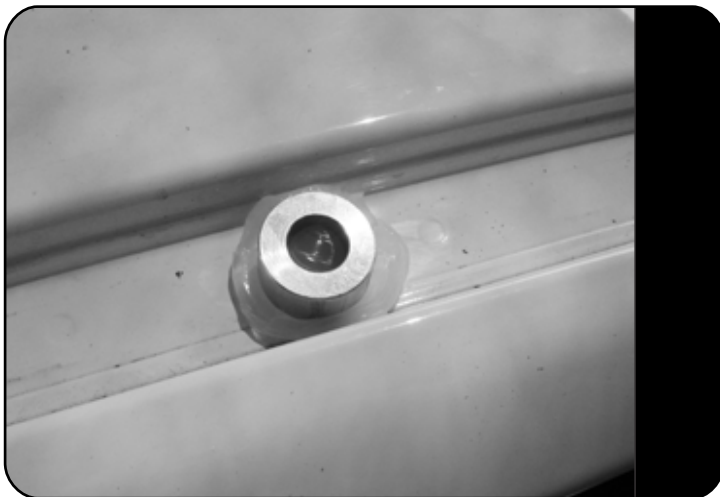

Clear the area around each mounting point using a rag and denatured alcohol.

Place a small amount of silicone over each mounting point, followed by one of the aluminium spacers supplied as shown.

There are ten spacers in total. The shorter spacers (Item 2) must be used on the two middle mounting points and the longer spacers (Item 3) must be used on the front and rear mounting points on either side of the vehicle.

Refit the ditch molding, lining up the holes in the ditch molding with the aluminium spacers.

2

FIT AND SECURE

2.7



Place the Foot Rails onto the vehicle, aligning the holes in the Foot Rail with the Spacers. There is a left and a right hand Foot Rail. The product sticker must be at the front of the vehicle, facing outward.

Hand tighten the Foot Rails to the roof using the M6 x 35 Hex Bolts, M6 SS Spring Washers and M6 x 19 x 1SS Flat Washers (Items 5, 6 & 7).

Measure the distance from the top of the windscreen to the first hole in each rail, ensuring that the left and right hand sides are of equal distance.

Fully tighten the bolts. Place M6 Nut Caps (Item 4) on all the Hex Bolt heads.

3

FIT AND SECURE

3.1

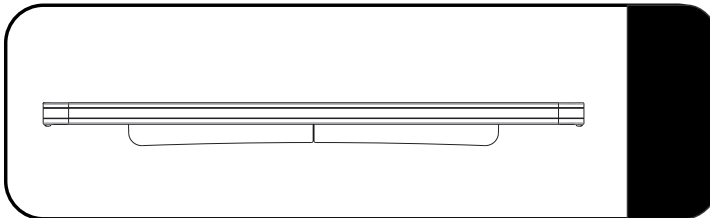

Make sure that the wind deflector is installed before you proceed to the next step.

3.2

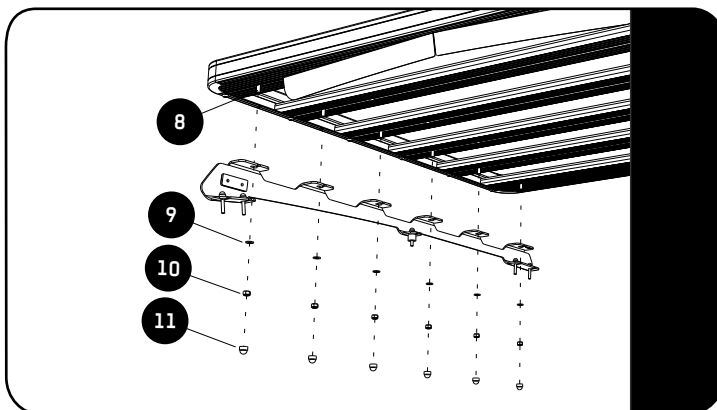

Fit your Roof Rack to the Foot Rails using M8 x 20 Hex Bolts, M8 x 16 x 1.6SS Flat Washers and M8 Nyloc Nuts (Items 8, 9 & 10) as shown.

3.3

Center the rack and tighten fully. Use M8 Nut Caps (Item 11) to finish off the nuts.



4

## COMPLETION

4.1

Congratulations! You did it. Take a step back and admire your work!



5

## INSTALL OTHER VEHICLE AND RACK ACCESSORIES

Now's the time to visit your favorite Front Runner Dealer in person or online.

### IMPORTANT!

FRONT RUNNER RACK KITS OFTEN HAVE A HIGHER LOAD RATING THAN THE VEHICLES THEY ARE MOUNTED TO. PLEASE REFER TO YOUR SPECIFIC VEHICLE MANUFACTURER FOR A RECOMMENDED ROOF RATING. FRONT RUNNER CANNOT BE RESPONSIBLE FOR IMPROPER LOADING BEYOND THE VEHICLE MANUFACTURER'S STATED LOAD CAPACITY.

Be sure to tag us. We love to see our gear in action! #FrontRunnerOutfitters #BornToRoam

Share your adventures on: 