

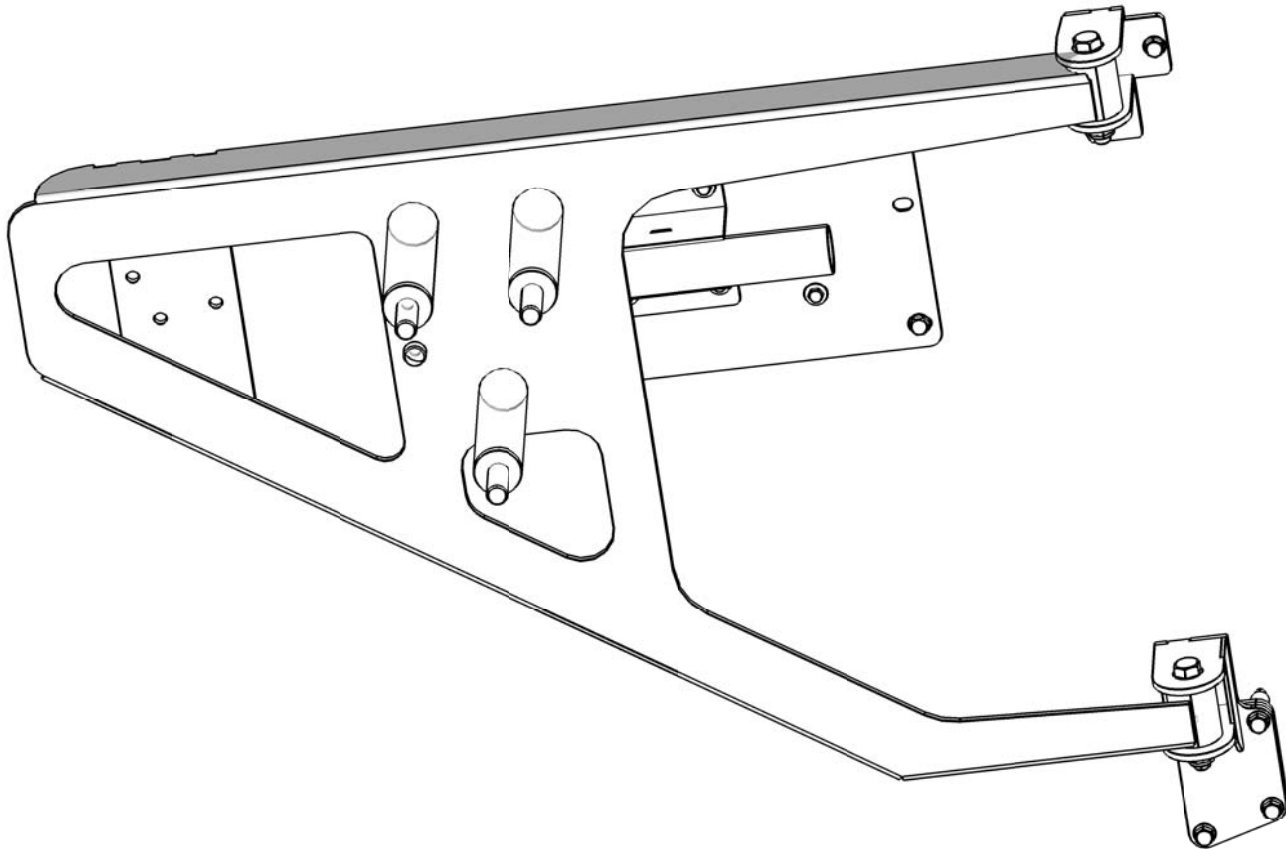

INSTALL TIME: 1.5 hours



**1**

## **GET ORGANIZED**

you will need:

- Land Rover Defender
- a Friend
- Clinch nut tool
- Drill machine
- 4,7, 8 & 9 mm drill bit
- 10,13,19,24 mm spanner or wrench
- Star screw driver

...CONT'D

### **IMPORTANT WARNING!**

IT IS CRITICAL THAT ALL FRONT RUNNER RACKS AND ACCESSORIES BE PROPERLY AND SECURELY ATTACHED TO YOUR VEHICLE. IMPROPER ATTACHMENT COULD RESULT IN AN AUTOMOBILE ACCIDENT, AND COULD CAUSE SERIOUS BODILY INJURY OR DEATH TO YOU OR TO OTHERS. YOU ARE RESPONSIBLE FOR SECURING THE RACKS AND ACCESSORIES TO YOUR CAR, CHECKING THE ATTACHMENTS PRIOR TO USE, AND PERIODICALLY INSPECTING THE PRODUCTS FOR ADJUSTMENT, WEAR, AND DAMAGE. THEREFORE, YOU MUST READ AND UNDERSTAND ALL OF THE INSTRUCTIONS AND CAUTIONS SUPPLIED WITH YOUR FRONT RUNNER PRODUCT PRIOR TO INSTALLATION OR USE. IF YOU DO NOT UNDERSTAND ALL OF THE INSTRUCTIONS AND CAUTIONS, OR IF YOU HAVE NO MECHANICAL EXPERIENCE AND ARE NOT THOROUGHLY FAMILIAR WITH THE INSTALLATION PROCEDURES, YOU SHOULD HAVE THE PRODUCT INSTALLED BY A PROFESSIONAL INSTALLER SUCH AS A QUALIFIED GARAGE OR AUTO BODY SHOP.

# 1

## GET ORGANISED

...CONT'D

Here is what you are looking at:

ITEM	QUANTITY	DESCRIPTION
1	1	SPARE WHEEL BRACKET
2	4	M8 X 50 HEX BOLT
3	2	M12 X 80 HEX BOLT
4	3	M8 X 35 HEX BOLT
5	1	SHOCK MOUNTING BRACKET
6	1	BODY STRENGTHENING PLATE
7	5	M8 NYLOC NUT
8	14	M8 FLAT WASHER
9	2	NYLON BUSH
10	4	M12 FLAT WASHER
11	1	TOP MOUNT BRACKET
12	8	M8 RIVNUT
13	2	SPACING BRACKET
14	1	BOTTOM MOUNT BRACKET
15	2	M12 NYLOC NUT
16	8	M6 NYLOC NUT
17	8	M6 X 35 HEX BOLT
18	16	M6 X 19 X 1 FLAT WASHER
19	4	M8 SPRING WASHER

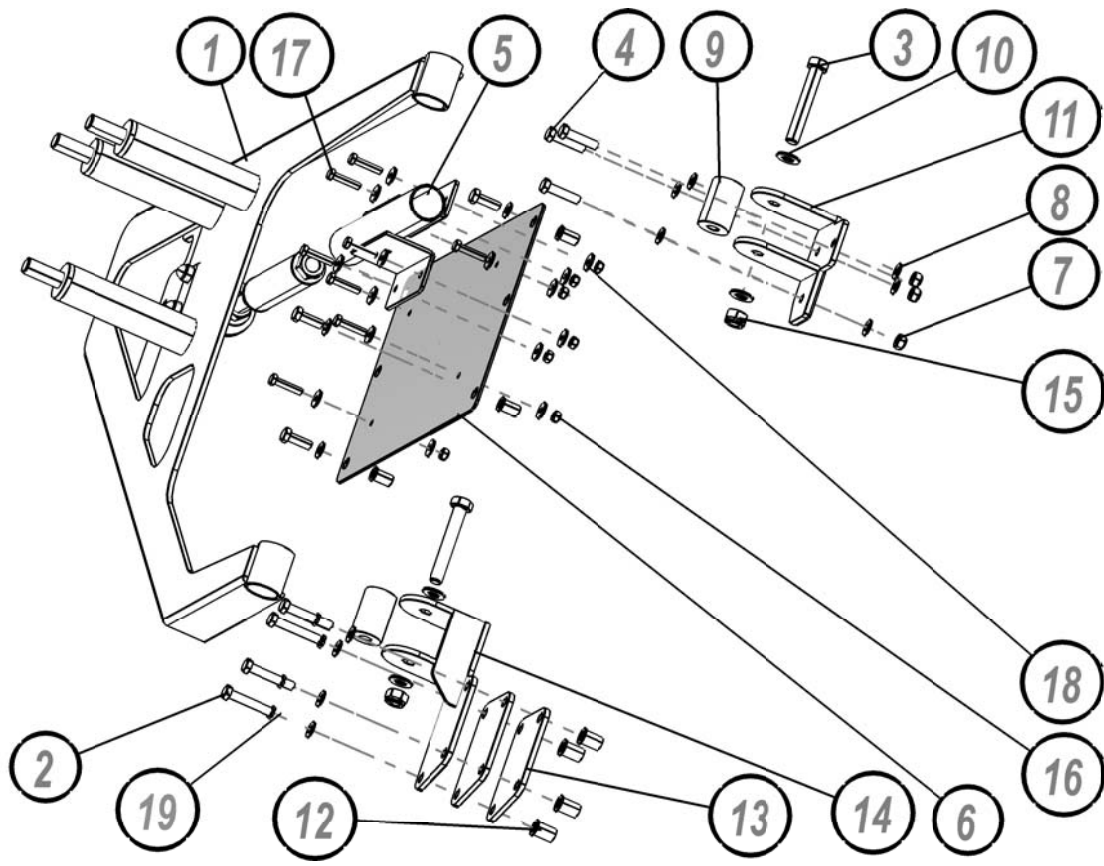

### A)

Familiarize yourself with the parts and then step away from the work area and read through these instructions from beginning to end. Grab a cup of coffee and take a moment. A little prep now may save you a lot of time later.

## 2 INSTALLATION OF SPARE WHEEL BRACKET

A)

Remove the back right cover inside the vehicle. The cover has two clips, inside the rear door. Remove the door panel cover, using a star screw driver.

**Note:** The cover is not the same on a puma and will look different if you are installing a wheel carrier to a Puma.



B)

**NOTE:** If you have an original spare wheel bracket, you will need to remove it (figure 1).

FIGURE 1

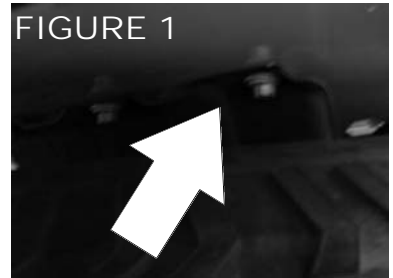

C)

Place the body strengthening plate on the door. Four holes will line up and you will need to mark the remaining two holes using your marking pen (figure 1 & 2). Take your drill machine and a 9 mm drill bit and drill all six holes (figure 3).

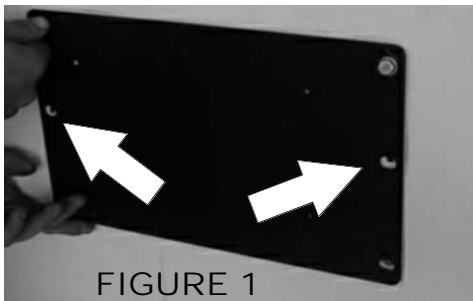

FIGURE 1

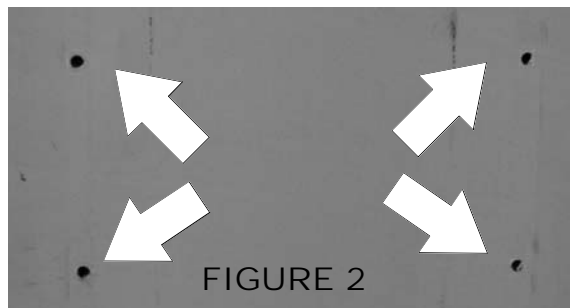

FIGURE 2

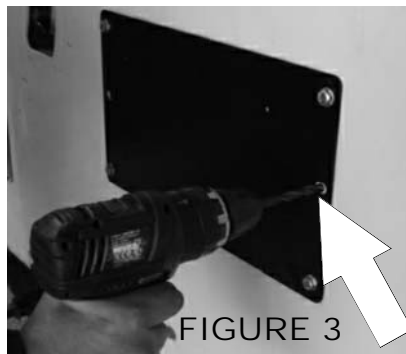

FIGURE 3

D)

In the 4 original holes you need to fit M8 clinch nuts in each hole using your clinch nut tool (figure 1). Fit four M8 x 25 hex bolt and flat washer.

For the two centre holes, fit two M8 x 20 hex bolts and flat washers. Behind fit a flat washer and nyloc nut (figure 2). Tighten all bolts.



FIGURE 1



FIGURE 2

## 2 INSTALLATION OF SPARE WHEEL BRACKET Cont

E)  
Looking at the back right of the vehicle, you will see three pop rivets joining the top body panel to the bottom body panel. The angled bracket will be placed on the body with angled side on the second pop rivet from the left top body panel (figure 1). From the second pop rivet, measure 43.5 mm and make a mark (Figure 2). The bracket will line up with the angled panel on the body, as the bracket has an angled ridge behind it (Figure 3). Mark your third hole at the bottom (figure 4). Using your drill machine and a 8 mm drill bit, drill the three holes. Fit three M8 x 35 hex bolts with flat washer and secure it with a flat washer and nyloc nut (figure 5 & 6). Do not tighten bolts.

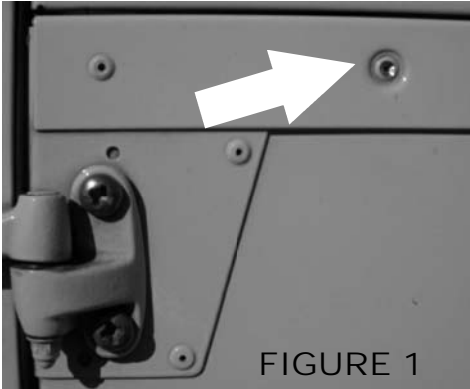

FIGURE 1

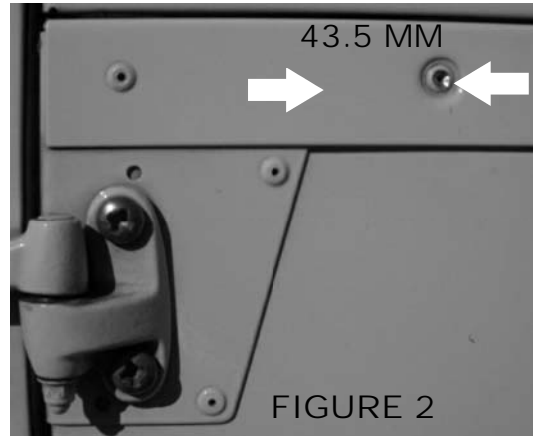

FIGURE 2

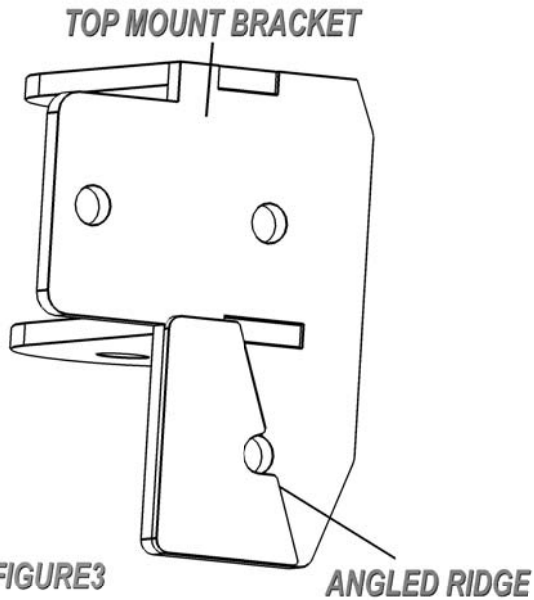

FIGURE 3

ANGLED RIDGE

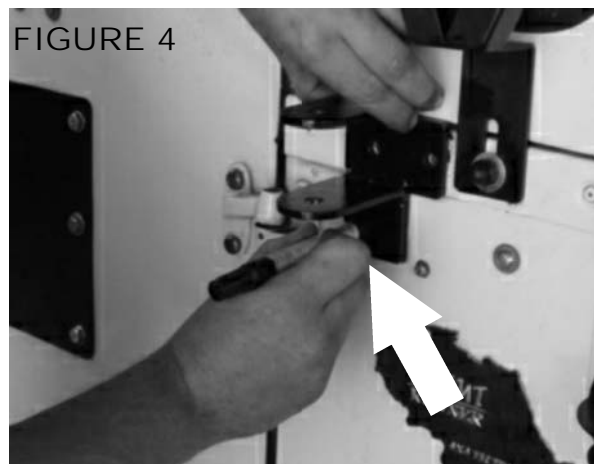

FIGURE 4

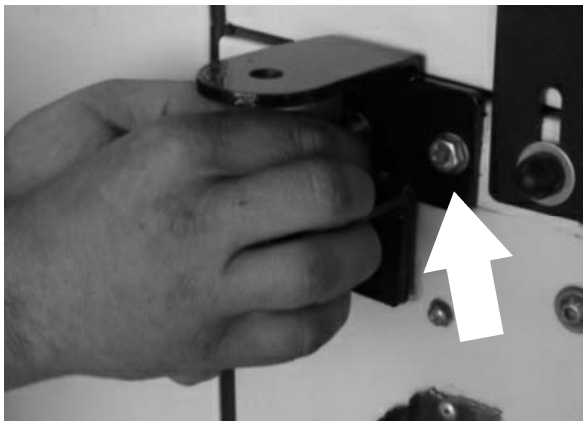

FIGURE 5  
OUTSIDE VEHICLE

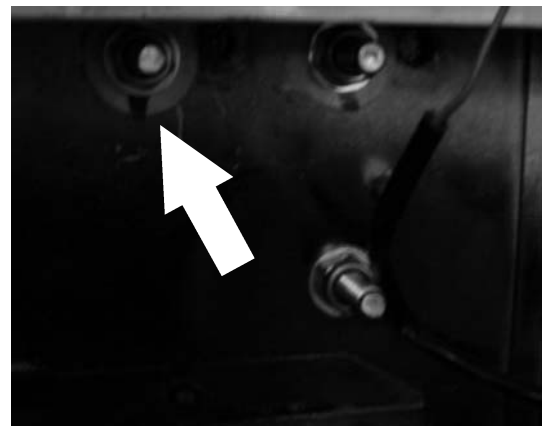

FIGURE 6  
INSIDE VEHICLE

# 2

## INSTALLATION OF SPARE WHEEL BRACKET Cont

F)

You will see four holes at the back right of the bumper (figure 1). With your clinch nut tool fit four M8 clinch nuts (figure 2). Fit the back bracket and two spacing brackets. First fit the two spacing plates (Item 13) then the bottom bracket. Use four M8 x 50 hex bolt, M8 Spring washer and M8 flat washer (figure 3 & 4). Do not tighten bolts yet.

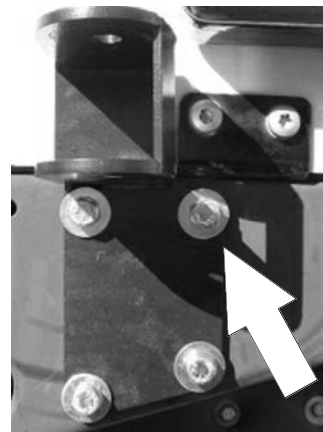
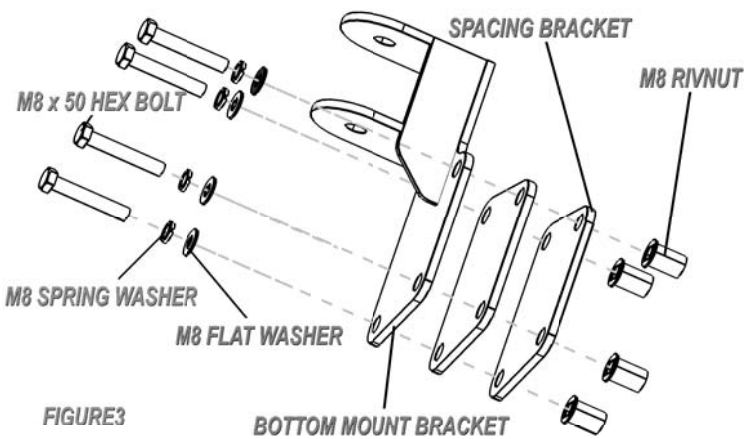
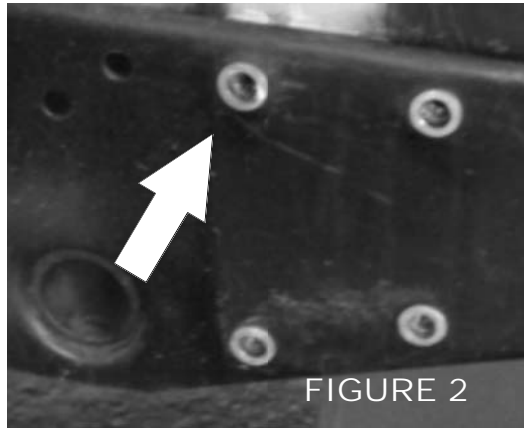
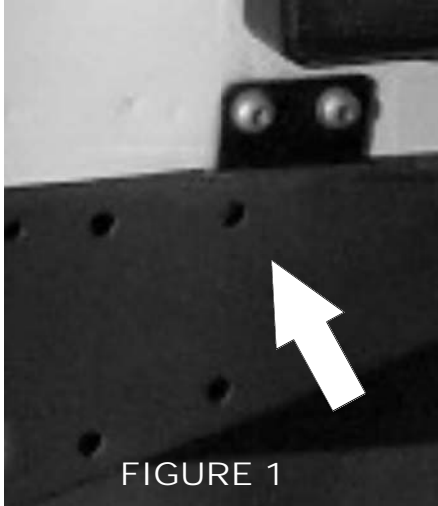
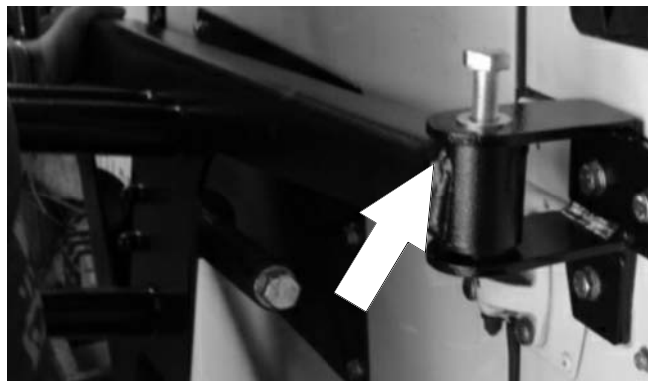
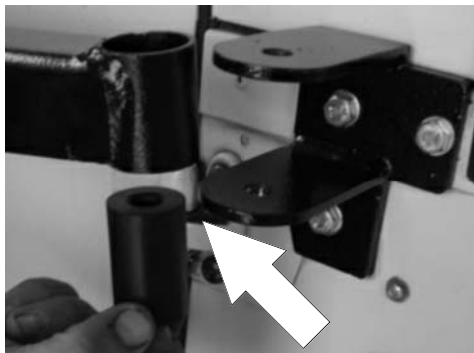

FIGURE 3

G)

Fit the two nylon bushes into the two holes as shown. Get your friend to give you a hand to line up the wheel bracket between the two mounting brackets. Fit two M12 x 80 hex bolt with M12 washers and nyloc nuts. Tighten your two mounting brackets and tighten the bolts on the wheel bracket.



## 2 INSTALLATION OF SPARE WHEEL BRACKET Cont

H)

Fit your guide bracket with the short side facing to the left side of the vehicle (Figure 1). Leave a gap of 2 to 3 mm (figure 2). Close the wheel bracket against the door and with your marking pen, mark the holes (figure 3).

Use your drill machine and a 4 mm drill bit, drill four pilot holes. Change drill bit to a 7 mm and drill holes again (figure 4). Fit four M6 x 35 hex bolt with flat washers. At the back use M6 flat washers and M6 nyloc nuts. Tighten bolts.

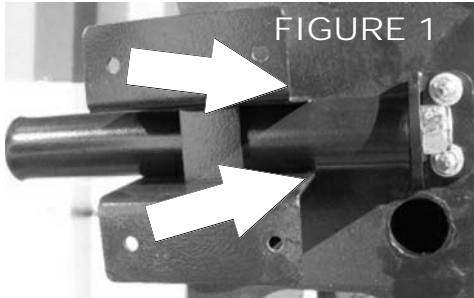

**NOTE:** The Nylon Bush needs to be adjusted until it fits snugly (no play) into the guide tube. This is done by tightening the two nuts as shown.

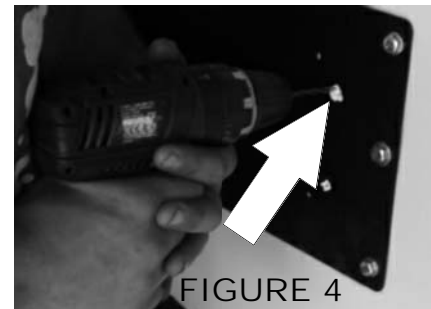
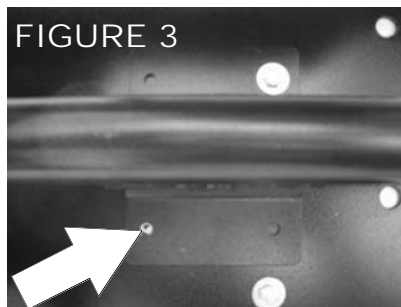
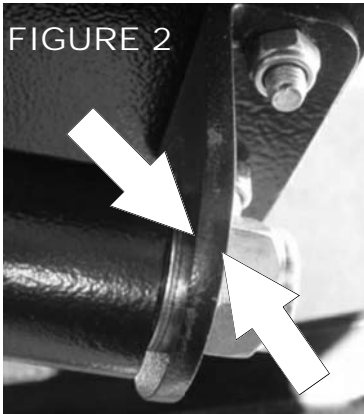

I)

Make sure all bolts are tight. Refit back door cover and rear window cover. Fit your spare wheel on. Make sure the door opens smoothly.

**NOTE:** It is important that the Spare Wheel tyre pushes up against the frame of the wheel carrier. If you are not using the original Mag Rim this might not occur. This could lead to product failure. Please add spacers in this event that brace the tyre.



Congratulations, you have completed the Spare Wheel Bracket installation.

**Modifying your vehicle involves some risks and may void certain aspects of your vehicle's warranty.**